



Car Radio | CD | MP3 | WMA

Seattle MP57



7 647 453 310

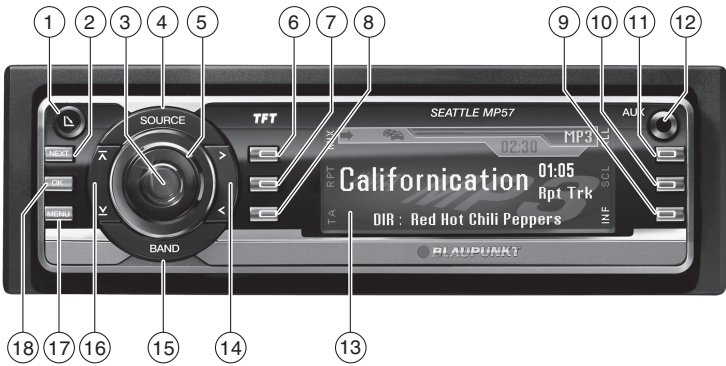

Bedienungsanleitung
Operating instructions
Mode d'emploi
Istruzioni d'uso
Gebruiksaanwijzing
Bruksanvisning

 **BLAUPUNKT**



- ①  button
to open the detachable control panel (flip-release panel).
- ② **NEXT** button
Selects FM memory banks or changes between MW and LW wavebands in radio mode.
Changes between MP3 display, MP3 browse mode and MP3 playlist mode in MP3 mode.
Changes between CD overview and CD changer display in CD changer mode.
Scrolls in multi-page menus.
- ③ On/Off button
Short press: Switches the device on.
In operation: Mutes the device.
Long press: Switches the device off.
- ④ **SOURCE** button
Source selection between radio and CD and (if connected or switched on) CD changer, AUX and FRONT AUX.
- ⑤ Volume control
- ⑥ to ⑪ softkeys
To select functions and menu items in the different operating modes (radio, CD, MP3, CD changer) and in the menu for basic settings. The respective function of a softkey is shown next to the softkey on the display. For further details, please read the section "Display elements" on the next page.
- ⑫ Front AUX-IN socket
- ⑬ Display (information about the individual display elements is located on the next page)
- ⑭ Arrow keys < or >
- ⑮ **BAND** button
Calls up the Tuner menu in radio mode.
- ⑯ Arrow keys ∇ or \blacktriangledown
- ⑰ **MENU** button
Calls up the menu for basic and audio settings.
- ⑱ **OK** button
Short press: Confirms menu settings. Ending the scan function.
Long press: Starts the Scan function.
- ⑲  button (eject)
to eject the CD from the device

The display in radio mode:

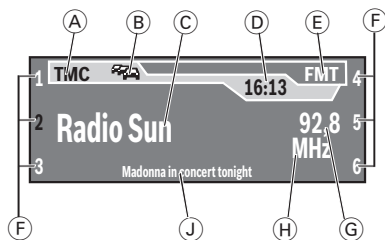

- (A) TMC symbol
- (B) Traffic jam symbol for priority for traffic information
- (C) Main line RDS station name or frequency
- (D) Clock
- (E) Level indicator Memory bank (e.g. FM1, FM2, FMT)
- (F) Memory location for radio stations which can be selected using the six softkeys (6) to (11)
- (G) Info line 1 Frequency of the station
- (H) Info line 2 Frequency unit (MHz or kHz)
- (J) Info line 3 Radio text, if supported by the station

Note:

The TMC symbol appears only if you connect an external navigation system and it starts searching for TMC stations.

The display in CD, CD changer and MP3 mode:

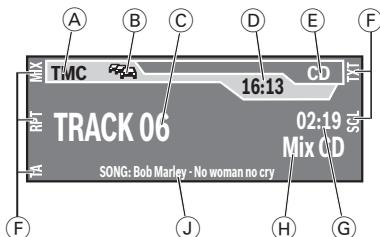

Note:

The figure shows the CD display. The functions and information of the CD changer and MP3 display may differ.

- (A) TMC symbol
- (B) Traffic jam symbol for priority for traffic information
- (C) Main line Track number/ID3 or file name
- (D) Clock
- (E) Level indicator Audio source (CD, CDC, MP3)
- (F) Functions which can be selected using the softkeys (6) to (11)
- (G) Info line 1 Playing time
- (H) Info line 2 Activated audio functions
- (J) Info line 3 CD text / CD name / title information

Contents

The display in radio mode:	58
The display in CD, CD changer and MP3 mode:	58
About these instructions	61
Symbols used.....	61
Use as directed.....	61
Declaration of conformity.....	61
For your safety	62
If you are installing device yourself....	62
Observe the following!.....	62
Cleaning instructions.....	63
Disposal of old unit	63
Scope of delivery	63
Optional equipment (not part of the scope of delivery)	63
Warranty.....	64
Service	64
Detachable control panel	65
Theft protection.....	65
Removing the control panel	65
Attaching the control panel.....	65
Switch-off time (Off Timer)	66
Timeout function	66
Switching on/off.....	66
Switching on/off with the On/Off button.....	66
Switching on/off using the vehicle ignition.....	66
Switching the device off using the detachable control panel.....	66
Switching demo mode on/off.....	67
Switching the welcome text on/off and changing it (Turn On Text)	67
Adjusting the volume	68
Adjusting the power-on volume (On Volume)	68
Quickly reducing the volume (Mute)..	68
Telephone Audio/Navigation Audio ...	69
Switching confirmation beep on/off (Beep)	70
Radio mode	70
Adjusting the tuner.....	70
Switching to radio mode	71
Convenient RDS functions (AF, REG) ..	71
Selecting the waveband (Band)/memory bank.....	71
Tuning into a station	72
Adjusting the sensitivity of the station seek tuning (Sensitivity)	72
Storing stations	73
Storing stations automatically (Travel Store)	73
Listening to stored stations	73
Scanning receivable stations (Scan) ..	73
Setting the scanning time (Scan Time)	74
Programme type (PTY)	74
Traffic information.....	76
Switching traffic information priority on/off	76
Adjusting volume for traffic announcements (Traffic Volume).....	76
CD mode	77
Switching to CD mode	77
Selecting tracks.....	78
Fast searching (audible).....	78
Random track play (MIX).....	78
Scanning tracks (Scan).....	78
Repeating tracks (RPT)	78
Displaying CD text.....	79
Ejecting a CD.....	79
MP3/WMA mode	80
Preparing an MP3 CD	80
Switching to MP3 mode	81
Adjusting the display (INF, ALL, SCL) ...	81
Selecting a directory	82
Selecting tracks/files.....	82

Selecting directories and track in MP3 browse mode	82
Selecting playlists and tracks in MP3 playlist mode	83
Fast searching (audible)	84
Random track play (MIX)	84
Scanning tracks (Scan)	84
Repeating individual tracks or whole directories (RPT)	84
CD changer mode	85
Switching to CD changer mode	85
Configuring the display	85
Selecting CDs	86
Selecting tracks	86
Fast searching (audible)	86
Repeating individual tracks or whole CDs (RPT)	86
Random track play (MIX)	87
Scanning all tracks on all CDs (Scan) ..	87
Naming a CD (CDN)	87
Clock	88
Adjusting the time (Time Setting)	88
Selecting the 12/24-hour clock mode (24 H Mode)	88
Displaying time permanently with device switched off and ignition switched on (Off Clock)	89
Sound	89
Adjusting Bass	90
Adjusting Treble	91
Setting the left/right volume distribution (balance)	91
Adjusting the front/rear volume distribution (fader)	91
Adjusting enhanced bass settings (Enhanced Bass)	91
Adjusting enhanced treble settings (Enhanced Treble)	92
Adjusting middle settings (Middle) ...	92
Preamplifier output (Preamp-Out/Sub-Out)	93
Adjusting the Sub-Out level and Sub-Out cut-off frequency (Subout) ...	93
X-Bass	94
Adjusting X-Bass boost (X-Bass)	94
Adjusting enhanced X-Bass settings (Enhanced X-Bass)	95
Equalizer presets (Presets)	95
Adjusting the display	96
Adjusting the display brightness (Brightness)	96
Adjusting the display viewing angle (Angle)	96
Activating/deactivating the screen saver (Screen Saver)	96
Changing wallpapers of the display ...	97
External audio sources	99
Connecting external audio sources ...	99
Switching on the rear AUX input and front AUX-IN socket (Auxiliary)	99
Naming external audio sources (Edit Auxiliary)	100
Restoring factory settings (Norm Set)	101
Technical data	102
Glossary	103
Index	105

About these instructions

These instructions contain important information to easily and safely install and operate the device.

- Read these instructions carefully and completely before using the device.
- Keep the instructions at a location so that they are always accessible to all users.
- Always pass on the device to third parties together with these instructions.

In addition, observe the instructions of the devices used in conjunction with this device.

Symbols used

These instructions employ the following symbols:



DANGER!

Warns against danger of injuries



CAUTION!

Warns about laser beam



CAUTION!

Warns about damaging the CD drive



The CE mark confirms the compliance with EU directives.

➔ Identifies a sequencing step

- Identifies a listing

Use as directed

This device is intended for installation and operation in a vehicle with 12 V vehicle system voltage and must be installed in a DIN slot. Observe the 'performance limits in the technical data. Repairs and installation, if necessary, should be performed by a specialist.

Declaration of conformity

The Blaupunkt GmbH declares that the Seattle MP57 device complies with the basic requirements and the other relevant regulations of the directive 89/336/EWG.

For your safety

The device was manufactured according to the state of the art and established safety guidelines. Even so, dangers may occur if you do not observe the safety notes in these instructions.

If you are installing device yourself

You may only install the device yourself if you are experienced in installing car sound systems and are very familiar with the electrical system of the vehicle. For this purpose, observe the installation instructions at the end of these instructions.

Observe the following!



CAUTION

The device contains a Class 1 laser that can cause injuries to your eyes.

Do not open the device and do not perform any modifications.

In operation

- For the front AUX-IN socket, use only the angled jack plug from Blaupunkt (7 607 001 535). All protruding parts, incl. straight plugs or adapters, can lead to an increased injury risk in case of an accident.
- Operate the device only if traffic situation permits it! Stop at a suitable location to perform extensive settings.
- Remove or attach the control panel only while the vehicle is standing an.

- To protect your hearing, always listen at a moderate volume. During mute phases (e.g. when changing the audio source or CD in the CD changer and Travelstore), changing the volume is not audible. Do not increase the volume during this mute phase.
- Always listen at a moderate volume so that you can always hear acoustic warning signals (e.g. police).

After operation

- The device is worthless to a thief without the control panel. Always remove the control panel whenever you leave the vehicle.
- Transport the control panel so that it is protected against impacts and the contacts cannot become dirty.

Cleaning instructions

Solvents, cleaning and scouring agents as well as dashboard spray and plastics care product may contain ingredients that will damage the surface of the device.

Use only a dry or slightly moistened cloth for cleaning the device.

Disposal of old unit



Do not dispose of your old unit in the household trash!

Use the return and collection systems available to dispose of the old device.

Scope of delivery

The scope of delivery includes:

- 1 Car sound system
- 1 Case for the control panel
- 1 Support frame
- 2 Disassembly bar
- 1 Guide pin
- 1 Operating instructions

Optional equipment (not part of the scope of delivery)

Use only accessories approved by Blaupunkt.

Remote control

The steering wheel and/or handheld remote control allows you to access the basic functions of your car sound system safely and conveniently.

You cannot switch the device on/off using the remote control!

You can find out from your Blaupunkt dealer or on the Internet at www.blaupunkt.com which remote controls can be used with your car sound system.

Amplifier

You can use all Blaupunkt and Velocity amplifiers.

CD changers

You can connect the following Blaupunkt CD changers:
CDC A 03, CDC A 08 and IDC A 09.

Warranty

We provide a manufacturer's warranty for products bought within the European Union. Devices purchased outside the European Union are subject to the warranty terms published by our respective regional agency.

The warranty terms can be called up under www.blaupunkt.com or requested directly from:

Blaupunkt GmbH
Hotline
Robert-Bosch-Str. 200
D-31139 Hildesheim, Germany

Service

In some countries, Blaupunkt offers a repair and pick-up service.

Information about the availability of this service in your country can be found at www.blaupunkt.com.

If you want to take advantage of this service, you may request a pick-up service for your device via the Internet.

Detachable control panel

Theft protection

The device is equipped with a detachable control panel (flip-release panel) as a way of protecting your equipment against theft. The device is worthless to a thief without this control panel.

Protect your device against theft by taking the control panel with you whenever you leave your vehicle. Do not leave the control panel inside your vehicle - not even in a hiding place.

Notes:

- Never drop the control panel.
- Do not expose the control panel to direct sunlight or another heat source.
- Avoid direct skin contact with the control panel's electrical contacts. If necessary, clean the contacts with a lint-free cloth moistened with cleaning alcohol.

Removing the control panel

- Press the  button ①.

The control panel opens to the bottom.

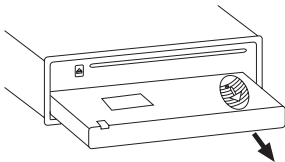

- Hold the control panel by its right side and then pull it **straight** out of the bracket.

Notes:

- The device is switched off after a time preset by you. For further details, please read the section "Switch-off time (Off Timer)" in this chapter.
- The device remembers the audio source played last for the next switch-on.
- Any CD already inserted in the device remains there.

Attaching the control panel

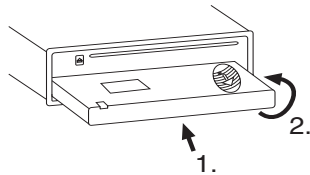

- Hold the control panel approximately at a right angle to the device. (see Figure, Step 1)
- Push the control panel into the guides at the bottom edge of the device.
- Push the control panel carefully into the bracket until it clicks into place.
- Fold the control panel up into the slot and press it gently into place until it clicks. (see Figure, Step 2)

If the device was still switched on when you detached the control panel, it will automatically switch on with the last setting activated (radio, CD, MP3, CD changer or AUX) when the panel is replaced.

Switch-off time (Off Timer)

After opening the control panel, the device is switched off after an adjustable time. You can set this time from 15 to 30 seconds.

➤ Press the **MENU** button (17).

The menu is displayed.

➤ Press the softkey "Various Settings" (9).

The "Various" menu is displayed.

➤ Press the softkey "Off Timer" (6).

The current switch-off time is displayed.

➤ Press the **∨** or **∧** button (16) or the **<** or **>** button (14) to adjust the switch-off time.

When you have finished making your changes,

➤ press the **OK** button (18) repeatedly until you reach the desired menu level for additional settings or completely exit the menu.

Timeout function

The device features a time-out function (time window).

For example, if you press the **MENU** button (17) and select a menu item, the device switches back to the display of the audio source after approx. 18 seconds after the last button activation. The settings performed are saved.

Switching on/off

There are various ways of switching the device on/off:

Switching on/off with the On/Off button

➤ For switch-on, press the On/Off button (3).

The device switches on.

➤ To switch off the device, press and hold down the On/Off button (3) for longer than two seconds.

The device switches off.

Note:

To protect the vehicle battery, the device will switch off automatically after one hour if the ignition is off.

Switching on/off using the vehicle ignition

The device will switch on/off simultaneously with the ignition if the device is correctly connected to the vehicle's ignition as shown in the installation instructions and you did not switch the device off by pressing the On/Off button (3).

Switching the device off using the detachable control panel

➤ Detach the control panel.

The device switches off after the time set in the menu. For further details, please read the section "Switch-off time (Off Timer)" in the chapter "Detachable control panel".

Switching demo mode on/off

The device is supplied from the factory with demo mode switched on. In demo mode, an animation plays on the display that shows the most important functions of the device.

The animation is shown for approx. 16 seconds after the last activation of the button. Pressing any button interrupts the animation and returns to the display of the current audio source.

To switch the demo mode on or off,

- press the **MENU** button (17) for longer than 4 seconds.

Switching the welcome text on/off and changing it (Turn On Text)

When you switch on the device, an animation appears, followed by a welcome text. The welcome text is factory set to "The advantage in your car".

You can switch the display of this welcome text on or off and enter your own welcome text of up to 35 characters.

Switching the welcome text on/off

To switch the welcome text on or off,

- press the **MENU** button (17).
- The menu is displayed.
- Press the softkey "Display Settings" (7).

The "Display" menu appears.

- Press the softkey "Turn On Text" (10):
 - : The welcome text is switched on.
 - : The welcome text is switched off.

When you have finished making your changes,

- press the **OK** button (18) repeatedly until you reach the desired menu level for additional settings or completely exit the menu.

Changing the welcome text

To change the welcome text,

- press the **MENU** button (17).
- The menu is displayed.
- Press the softkey "Various Settings" (9).

The "Various" menu is displayed.

- Press the softkey "Turn On Text" (8).

The 35-character text input is displayed. The first character is highlighted.

To switch between the entry positions,

- press the < or > button (14).

To select a character at an entry position,

- press the **↖** or **↘** button (16).

To save the name entered and to exit the text input,

- press the **OK** button (18).

Adjusting the volume

You can adjust the volume in increments from 0 (off) to 66 (maximum).

To increase the volume,

- turn the volume control (5) clockwise.

To decrease the volume,

- turn the volume control (5) counter-clockwise.

Adjusting the power-on volume (On Volume)

You can set the power-on volume. To set a specific power-on volume,

- press the **MENU** button (17).

The menu is displayed.

- Press the softkey "Volume Settings" (8).

The "Volume" menu is displayed.

- Press the softkey "On Volume" (11).

The current power-on volume is displayed.

- Press the **V** or **^** button (16) or the **<** or **>** button (14) to adjust the power-on volume between 1 and 66.

To help you adjust the setting more easily, the device will increase or decrease the volume as you make your changes.

When you have finished making your changes,

- press the **OK** button (18) repeatedly until you reach the desired menu level for additional settings or completely exit the menu.

As an alternative, you can select the setting "Last Volume" in the "Volume" menu by pressing the softkey (10). When you switch on the device, the volume level that was set the last time you switched the device off is activated again.

Notes:

- To protect your hearing, the power-on volume is limited to the value "38" for the setting "Last Volume". If the volume was higher before switch-off, the value is automatically set to "38" at switch-on. This prevents an unintentionally and unexpectedly high volume when switching on the device.
- To undo the "Last Volume" setting, press the softkey "On Volume" (11) in the "Volume" menu. The power-on volume set last is displayed and is active again. You can now leave the menu by pressing the **OK** button (18) or directly set a different power-on volume.

Quickly reducing the volume (Mute)

You can quickly reduce the volume to a pre-set level.

- Briefly press the On/Off button (3).

"MUTE" appears on the display.

Cancelling mute

To return to your previously set volume level,

- briefly press the On/Off button (3) again.

Adjusting the mute volume (Mute Volume)

The mute volume is adjustable.

➔ Press the **MENU** button (17).

The menu is displayed.

➔ Press the softkey "Volume Settings" (8).

The "Volume" menu is displayed.

➔ Press the softkey "Mute Volume" (8).

The current setting is displayed.

➔ Press the **∇** or **∧** button (16) or the **<** or **>** button (14) to adjust the volume between 1 and 66.

When you have finished making your changes,

➔ press the **OK** button (18) repeatedly until you reach the desired menu level for additional settings or completely exit the menu.

Telephone Audio/Navigation Audio

Muting during telephone mode

If your car sound system is connected with a cell phone or navigation system, answering the phone or a voice output of the navigation automatically mutes the car sound system. The call or the voice output is played back via the loudspeakers of the car sound system. In order for this feature to work, the mobile telephone or navigation system must be connected to the car sound system as described in the installation instructions.

You can find out from your Blaupunkt dealer which navigation systems can be used with your car sound system.

If you answer a call or a navigation announcement takes place, the display shows "Phone Call".

Adjusting the volume for telephone audio/navigation audio (Phone Volume)

During a telephone call or a voice output of the navigation, no traffic announcements are switched through. The traffic announcement is not recorded!

You can set the volume level at which the telephone calls or navigation announcements are mixed in.

➔ Press the **MENU** button (17).

The menu is displayed.

➔ Press the softkey "Volume Settings" (8).

The "Volume" menu is displayed.

➔ Press the softkey "Phone Volume" (7).

The current setting is displayed.

➔ Press the **∇** or **∧** button (16) or the **<** or **>** button (14) to adjust the volume between 1 and 66.

When you have finished making your changes,

➔ press the **OK** button (18) repeatedly until you reach the desired menu level for additional settings or completely exit the menu.

Note:

You can use the volume control (5) to adjust the volume of telephone calls and navigation announcements whilst you are listening to them.

Switching confirmation beep on/off (Beep)

The system will output a confirmation beep for some functions if you keep a button pressed down for longer than two seconds, for instance, when assigning a radio station to a station preset button. You can switch the beep on or off.

➤ Press the **MENU** button (17).

The menu is displayed.

➤ Press the softkey "Volume Settings" (8).

The "Volume" menu is displayed.

To switch the confirmation beep on or off,

➤ press the softkey "Beep" (9):

- : The confirmation beep is switched on.
- : The confirmation beep is switched off.

When you have finished making your changes,

➤ press the **OK** button (18) repeatedly until you reach the desired menu level for additional settings or completely exit the menu.

Radio mode

This device is equipped with an RDS radio receiver. Many of the receivable FM stations broadcast a signal that not only carries the programme but also additional information such as the station name and programme type (PTY).

The station name appears on the display as soon as the tuner receives it.

Adjusting the tuner

To ensure proper functioning of the tuner, the device must be set for the region in which it is being operated. You can select between Europe "EUROPE", America "USA" and Thailand "THAILAND". The tuner is factory-set to the region in which it was sold. If you experience problems with your radio reception, check this setting.

Note:

The radio functions described in these operating instructions refer to the tuner setting EUROPE.

➤ Switch off the device by pressing the On/Off button (3).

➤ Press and hold the softkeys (8) and (11) at the same time and switch on the device again using the On/Off button (3).

The "Area" menu with the available regions "EUROPE", "USA" and "THAILAND" as well as the current setting is displayed.

➤ Select your tuner region with the corresponding softkey "USA" (6), "EUROPE" (7) or "THAILAND" (8).

To save the setting,

- press the **OK** button (18). The radio starts with the setting selected last (radio, CD, MP3, CD changer or AUX).

Switching to radio mode

If you are in CD, MP3, CD changer or AUX mode,

- press the **BAND** button (15).

or

- press the **SOURCE** button (4) repeatedly until "TUNER" appears on the display.

Convenient RDS functions (AF, REG)

The convenient RDS functions AF (Alternative Frequency) and REGIONAL extend your radio's range of functions.

- **AF:** If the RDS function is activated, the radio automatically tunes into the best receivable frequency for the station that is currently set.
- **REGIONAL:** At certain times, some radio stations divide their programme into regional programmes providing different content. You can use the REG function to prevent the car radio from switching to alternative frequencies that are transmitting different programme content.

Note:

REGIONAL must be activated/deactivated separately in the "Tuner" menu.

Switching REGIONAL on/off

- Press the **BAND** button (15).

The "Tuner" menu is displayed.

To switch REGIONAL on/off,

- press the softkey "Regional" (8):
 - : REGIONAL is switched on.
 - : REGIONAL is switched off.

To save the setting,

- press the **OK** button (18).

Switching convenient RDS function on or off (RDS)

- Press the **BAND** button (15).

The "Tuner" menu is displayed.

To switch the RDS functions AF and REGIONAL on or off,

- press the softkey "RDS" (10):
 - : RDS is switched on.
 - : RDS is switched off.

To save the setting,

- press the **OK** button (18).

Selecting the waveband (Band)/ memory bank

This device can receive programmes broadcast over the FM frequency range as well as the MW and LW (AM) wavebands. There are three memory banks available for the FM waveband (FM1, FM2 and FMT) and one for each of the MW and LW wavebands.

Six stations can be stored in each memory bank.

To switch between the wavebands FM, MW and LW,

➤ press the **BAND** button (15).

The "Tuner" menu is displayed.

➤ Press the softkey "Band" (7) in FM mode or (6) in AM mode.

The "Band" menu for the selection of the waveband is displayed.

➤ Press the softkey "FM" (6), "MW" (7) or "LW" (11).

The radio changes to the selected waveband.

To switch between the memory banks FM1, FM2 and FMT in the FM waveband or between MW and LW in the AM waveband,

➤ press the **NEXT** button (2).

Tuning into a station

There are various ways of tuning into a station.

Automatic station seek tuning

➤ Press the **V** or **^** button (16).

The radio tunes into the next receivable station.

Note:

If the priority for traffic information is active (the display shows the traffic jam symbol (B)), the next traffic information station is set.

Tuning into stations manually

You can also tune into stations manually.

Note:

You can only tune into stations manually if the convenient RDS function is deactivated.

To change the set frequency in small increments,

➤ briefly press the **<** or **>** button (14).

To change the set frequency quickly,

➤ press and hold down the **<** or **>** button (14) for a longer period of time.

Browsing through broadcasting networks (FM only)

If a radio station provides several programmes, you have the option of browsing through its so-called "broadcasting network".

Note:

The convenient RDS function must be activated before you can use this feature.

➤ Press the **<** or **>** button (14) to switch to the next station on the broadcasting network.

Note:

When using this feature, you will only be able to switch to stations that you have received once before already. To receive the stations, use the Scan or Travelstore function.

Adjusting the sensitivity of the station seek tuning (Sensitivity)

You can choose whether the radio should only tune into stations providing good reception or whether it can also tune into those with a weak reception. The sensitivity can be adjusted from 1 (low) to 6 (high).

➤ Press the **BAND** button (15).

The display shows the first page of the "Tuner" menu.

- Change to the second page of the "Tuner" menu by pressing the **NEXT** button (2).
- Press the softkey "Sensitivity" (8) repeatedly until the desired sensitivity level is displayed behind "Sensitivity".

When you have finished making your changes,

- press the **OK** button (18).

Note:

The device stores the sensitivity value set in the respective FM and AM waveband.

Storing stations

Storing stations manually

- Select the desired memory bank (FM1, FM2, FMT) or one of the wavebands (MW or LW).
- Tune into the desired station.
- Briefly press on the softkeys (6) to (11).

The assignment of all six memory locations is displayed.

- Press and hold down one of the softkeys (6) to (11) for longer than two seconds to assign the station to that button.

Storing stations automatically (Travel Store)

You can automatically store the six stations offering the strongest reception in the region (FM only). The stations are stored in the FMT memory bank.

Note:

Any stations that were previously stored in this memory bank are deleted in the process.

- Press the **BAND** button (15).
The "Tuner" menu is displayed.
- Press the softkey "Travel Store" (9).

The storing procedure begins. "Travel Store" appears on the display. After the process has completed, the radio will play the station that is stored in memory location 1 of the FMT memory bank.

Note:

If the priority for traffic information is active (the display shows the traffic jam symbol), only traffic information stations are stored.

Listening to stored stations

- Select the memory bank or waveband.
- Briefly press on the softkeys (6) to (11).

The assignment of all six memory locations is displayed.

- Press the softkey (6) to (11) where the desired station is stored.

The stored station is played if it can be received.

Scanning receivable stations (Scan)

You can use the scan function to play all the receivable stations briefly. You can set the scanning time in the menu to between 5 and 30 seconds.

Starting Scan

➤ Press and hold down the **OK** button (18) for longer than 2 seconds.

The radio scans the next receivable station. "SCAN" and the current frequency or the station name appear intermittently on the display.

Cancelling the scan and continuing to listen to a station

➤ Press the **OK** button (18).

Scanning stops and the radio continues playing the station that it tuned into last.

Setting the scanning time (Scan Time)

➤ Press the **MENU** button (17).

The menu is displayed.

➤ Press the softkey "Various Settings" (9).

The "Various" menu is displayed.

➤ Press the softkey "Scan Time" (10).

The current setting is displayed.

➤ Press the **∨** or **∧** button (16) or the **<or>** button (14) to set the desired scanning time.

When you have finished making your changes,

➤ press the **OK** button (18) repeatedly until you reach the desired menu level for additional settings or completely exit the menu.

Note:

The defined scanning time is also applied by the system to scanning carried out in CD and CD-changer as well as MP3 mode.

Programme type (PTY)

Besides transmitting the station name, some FM stations also provide information on the type of programme that they are broadcasting. Your car radio can receive and display this information.

For example, the programme types can be:

CULTURE	TRAVEL	JAZZ
SPORT	SERVICE	POP
ROCK	KNOWLEDGE	KIDS

You can use the PTY function to select stations of a particular programme type.

PTY-EON

If you specify the programme type and start seek tuning, the radio will switch from the current station to a station of the selected programme type.

Notes:

- If the tuner does not find a station that corresponds to the selected programme type, you will hear a beep and "NO PTY" appears briefly in the display. The radio will then retune to the station that it received last.
- If the tuned radio station or another station on the broadcasting network broadcasts your selected programme type at a later point in time, the radio will automatically switch from the currently tuned station or from CD mode or CD-changer mode to the station whose programme type matches the one you selected.
- If you do not want this PTY EON switching, disable PTY. First, switch to radio mode with the **SOURCE** (4)

or **BAND** button (15). In CD or CD changer mode, the required menu is not available.

Switching PTY on/off (Program Type)

To switch on PTY, select a programme type. For further details, read the section "Selecting the programme type and starting seek tuning" in this chapter.

To switch off PTY,

➤ press the **BAND** button (15).

The display shows the first page of the "Tuner" menu.

➤ Change to the second page of the "Tuner" menu by pressing the **NEXT** button (2).

➤ Press the softkey "Program Type" (11).

The "PTY" menu is displayed.

➤ Press the softkey "PTY OFF" (6).

When you have finished making your changes,

➤ press the **OK** button (18).

Selecting the PTY language (Program Lang)

You can select the language for the display of the programme types. Options include DEUTSCH, ENGLISH and FRANÇAIS.

➤ press the **BAND** button (15).

The display shows the first page of the "Tuner" menu.

➤ Change to the second page of the "Tuner" menu by pressing the **NEXT** button (2).

➤ Press the softkey "Program Lang" (9).

The "PTY LANG" menu is displayed.

To select a language,

➤ press the softkey "English" (6), "Français" (8) or "Deutsch" (11).

When you have finished making your changes,

➤ press the **OK** button (18).

Selecting the programme type and starting seek tuning (Program Type)

➤ Press the **BAND** button (15).

The display shows the first page of the "Tuner" menu.

➤ Change to the second page of the "Tuner" menu by pressing the **NEXT** button (2).

➤ Press the softkey "Program Type" (11).

The "PTY" menu is displayed.

If the desired programme type is not offered in the current view,

➤ scroll through the "PTY" menu with the **NEXT** button (2).

To select a programme type,

➤ press the corresponding softkey (7) to (11).

➤ Press the **√** or **∧** button (16) to start seek tuning.

The radio will then tune into the next station that it finds that corresponds to your selected programme type.

Note:

After selecting a programme type, you can also exit the "PTY" menu with the **OK** button (18) without starting the seek tuning. As long as a programme type is selected, you can also start the PTY seek tuning in regular radio mode with the **√** or **∧** button (16).

Traffic information

Your device is equipped with an RDS-EON receiver. EON (**E**nanced **O**ther **N**etwork) ensures that whenever a traffic announcement (TA) is broadcast, the system switches automatically from a station that does not provide traffic reports to the appropriate traffic information station within the broadcasting network that does.

Once the traffic announcement has been played, the system will switch back to the programme that you were listening to before.

Switching traffic information priority on/off

The priority for traffic announcements is activated if the display shows the traffic jam symbol .

Notes:

After approx. 16 seconds, a warning beep sounds,

- if you leave the reception area of a traffic information station that you are currently listening to.
- if you leave the reception area of a traffic information station that the system is tuned into while you are in the CD or CD changer mode, and the subsequent automatic seek tuning cannot find a new traffic information station.
- if you retune the radio from a traffic information station to a station that does not broadcast traffic information.

If you hear the warning beep, you can either switch off traffic information priority or tune into a station that broadcasts traffic information.

Switching priority for traffic information on/off in radio mode (Traffic)

To switch priority for traffic information on/off in radio mode,

- ➔ press the **BAND** button .

The display shows the first page of the "Tuner" menu.

- ➔ Press the softkey "Traffic"  to switch priority for traffic information on or off:
 - : Priority for traffic information is switched on.
 - : Priority for traffic information is switched off.

When you have finished making your changes,

- ➔ press the **OK** button .

Switching priority for traffic information on/off in CD, CD changer and MP3 mode (TA)

To switch priority for traffic information on/off in CD, CD changer and MP3 mode,

- ➔ press the softkey "TA" .

Adjusting volume for traffic announcements (Traffic Volume)

- ➔ Press the **MENU** button .

The menu is displayed.

- ➔ Press the softkey "Volume Settings" .

The "Volume" menu is displayed.

➔ Press the softkey "Traffic Volume" (6).

The current setting is displayed.

➔ Press the ∇ or \blacktriangleright button (16) or the \langle or \rangle button (14) to adjust the volume between 1 and 66.

To help you adjust the setting more easily, the device will increase or decrease the volume as you make your changes.

When you have finished making your changes,

➔ press the **OK** button (18) repeatedly until you reach the desired menu level for additional settings or completely exit the menu.

Notes:

- Using the volume control (5), you can also adjust the volume during a traffic announcement for the duration of that announcement.
- During traffic reports, you can adjust the sound settings and volume distribution settings for traffic announcements. For further details, please read the "Sound" chapter.

CD mode

You can use this device to play standard audio CDs, CD-Rs and CD-RWs with a diameter of 12 cm.



Risk of severe damage to the CD drive!

CD singles with a diameter of 8 cm and noncircular contoured CDs (shape CDs) must not be used.

We accept no responsibility for any damage to the CD drive that may occur as a result of the use of unsuitable CDs.

To ensure proper functioning, use only CDs with the Compact-Disc logo. Copy-protected CDs can cause playback problems. Blaupunkt cannot guarantee the proper functioning of copy-protected CDs!

Besides being able to play audio CDs on this device, you can also play CDs containing MP3/WMA music files. For further information, please read the chapter entitled "MP3/WMA mode".

Switching to CD mode

If there is no CD inserted in the drive,

➔ press the \blacktriangleleft button (1).

The control panel opens.

➔ Gently insert the CD with its printed side uppermost into the drive until you feel some resistance.

The drive draws in the CD automatically.

You must not hinder or assist the drive as it draws in the CD.

➤ Gently close the control panel whilst exerting a little pressure until you feel it click into place.

The CD playback starts and "CD" is shown on the display.

Note:

If the vehicle ignition was switched off prior to inserting the CD, you must switch the device on first with the On/Off button (3) to start the playback.

If a CD is already inserted in the drive,

➤ press the **SOURCE** button (4) repeatedly until "CD" appears on the display.

Playback begins from the point at which it was last interrupted.

Selecting tracks

➤ Press an arrow button (14) or (16) to select the next or previous track.

If you press the < (14) or √ button (16) once, the player will play the current track again from the beginning.

Fast searching (audible)

To fast search backwards or forwards,

➤ press and hold down the (14) or (16) arrow button until fast searching backwards or forwards begins.

Random track play (MIX)

➤ Press the softkey "MIX" (6).

"MIX ALL" briefly appears on the display, info line 2 (H) permanently displays "Mix All". The next randomly selected track will then be played.

Cancelling MIX

➤ Press the softkey "MIX" (6) again.

"MIX OFF" briefly appears on the display, info line 2 (H) no longer displays "Mix All".

Scanning tracks (Scan)

You can scan (briefly play) all the tracks on the CD.

➤ Press the **OK** button (18) for longer than 2 seconds.

The next track will then be scanned. "SCAN" and the current track number are intermittently shown on the display.

Note:

You can set the scan time. For further information, please read the section entitled "Setting the scanning time" in the "Radio mode" chapter.

Cancelling Scan and continuing listening to a track

To end the scanning process,

➤ press the **OK** button (18).

The currently scanned track will then continue to be played normally.

Repeating tracks (RPT)

If you want to repeat a track,

➤ press the softkey "RPT" (7).

"REPEAT TRACK" briefly appears on the display, info line 2 (H) permanently displays "Rpt Trk". The track is repeated continuously until you deactivate Repeat.

Cancelling repeat

If you want to cancel the repeat function,

➡ press the softkey "RPT" (7) again.

"REPEAT OFF" briefly appears on the display, info line 2 (H) no longer displays "Rpt Trk". Normal playback is then resumed.

Displaying CD text

Some CDs include CD text. The CD text might contain the names of the artist and the album.

The CD text is displayed as scrolling text.

Switching CD text on/off (TXT, SCL)

➡ Press the softkey "TXT" (11).

If CD text is switched on or off, the display briefly shows "CD Text On" or "CD Text Off".

If the CD provides CD text and CD text is switched on, the CD text is displayed in info line 3 (J).

Note:

If the CD text is too long to be completely displayed, you can use the softkey "SCL" (10) to display the CD text as scrolling text.

Ejecting a CD

➡ Press the  button (1).

The control panel opens to the bottom.

➡ Press the  button (19) next to the CD compartment.

The CD is ejected.

➡ Remove the CD and close the control panel.

Notes:

- If a CD is ejected, the drive will automatically draw it back in again after approx. 10 seconds.
- You can also eject CDs whilst the device is switched off or whilst another audio source is activated.

MP3/WMA mode

You can also use this car sound system to play CD-Rs and CD-RWs that contain MP3 music files. You can also play WMA files.

This chapters deals only with playing MP3 files since the operation for MP3 and WMA files is identical.

Notes:

- WMA files with Digital Rights Management (DRM) from online music shops cannot be played with this device.
- WMA files can only be played back safely if they were created with Windows Media Player version 8 or later.

Preparing an MP3 CD

The various combinations of CD burners, CD burning software and CD blanks may lead to problems arising with the device's ability to play certain CDs. If problems occur with your own burned CDs, you should try another brand of CD blank or choose another colour of CD blank. To avoid problems when playing self-burned CDs, you should not burn CDs at speeds greater than 16-speed.

The format of the CD must be ISO 9660 Level 1/Level 2 or Joliet. Other formats cannot be played reliably.

When creating (coding) MP3/WMA files from audio files, you should use bit rates from 32 to 320 kbit/s for MP3 files or 32 to 192 kbps for WMA files.

MP3 tracks can contain additional information such as the artist, album and track name (ID3 tags). This device can display ID3 tags of version 1 and 2.

This device can manage up to 999 tracks in 99 directories. The directories and tracks on the CD can be selected individually.

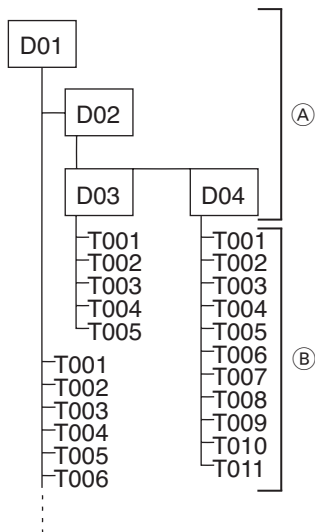

- (A) Directories
(B) Tracks · Files

You can name each directory using a PC. The device is capable of displaying the directory name. Name the directories and tracks/files using your CD burner software. The software's instruction manual will provide details on how to do this.

Notes:

- When naming files (directories and tracks) you should avoid using accents and special characters.
- If you use file names with more than 16 characters (including ".MP3" or ".WMA"), the maximum number of tracks and directories is reduced.

If you like your files to be in the specific order, save the files on the data carrier in the desired sequence in which you want to play them later. The device plays back the files in the order in which they were physically stored on the data carrier.

To play back files in this device, the MP3 files must have the file extension ".MP3" and the WMA files the file extension ".WMA".

Notes:

To ensure uninterrupted playback,

- do not try changing the file extension to ".MP3" of any files other than MP3 files and then attempt to play them! The device will ignore these invalid files during playback.
- Do not use "mixed" CDs containing both non-MP3 data and MP3 tracks (the device only reads MP3 files during MP3 playback).
- Do not use mix-mode CDs containing both CD-audio tracks and MP3 tracks. If you try playing a mix-mode CD, the device will only play the CD-audio tracks.

Switching to MP3 mode

For an MP3 CD, the MP3 mode is activated in the same way as the normal CD mode. For further information, please read the section entitled "Switching to CD mode" in the "CD mode" chapter.

Adjusting the display (INF, ALL, SCL)

Info line 3  can display different information about the current track:

- File name
- Directory name
- Track name
- Name of the artist
- Name of the album

To switch between the different display options,

- press the softkey "INF"  once or several times until the desired display appears.

To display all the available information once as scrolling text,

- press the softkey "ALL" .

Notes:

- If the information is too long to be completely displayed, you can use the softkey "SCL"  to display the information as scrolling text.
- Artist and album name are a component of the MP3 ID3 tag of version 1 and version 2 and can only be displayed if they were stored with the MP3 files. For further details, please read the instructions of your PC MP3 software or burner software.

Selecting a directory

To move up or down to another directory,

➤ press the **↵** or **↶** button (16) once or several times.

Notes:

- The device will automatically skip and not display any directories that do not contain MP3 files.
- The device treats all directories and subdirectories as if they were located on one level. Repeatedly pressing the **↵** or **↶** button (16) will also bring you to all subdirectories.

Selecting tracks/files

To move up or down to another track/file in the current directory,

➤ press the **<** or **>** button (14) once or several times.

If you press the **<** (14) button once, the current track will be played again from the beginning.

Selecting directories and track in MP3 browse mode

In MP3 browse mode, the tracks and directories of the MP3 CD are displayed as they are physically stored on the CD in directories and subdirectories. For this purpose, a four-line display is shown in MP3 browse mode. This display shows all the tracks and subdirectories of the current directory as a list. You can select and play a track in this list or select and open a subdirectory. In addition, you can change to the higher level directory if you are currently in a subdirectory.

Selecting and exiting MP3 browse mode

To change from MP3 display to MP3 browse mode,

➤ press the **NEXT** button (2).

The "BROWSE" menu is displayed with a list of the subdirectories and tracks of the current directory. The current track is selected in the list.

To exit MP3 browse mode again,

➤ press the **NEXT** button (2).

The MP3 display is shown.

Notes:

- If the CD also contains MP3 or WMA playlists, pressing the **NEXT** button (2) brings you to the playlist mode from the MP3 browse mode (see the section "Selecting playlists and tracks in MP3 playlist mode" in this chapter). In this case, press the **NEXT** button (2) a second time to return to the MP3 display.
- The functions of the MP3 display (e.g. Mix and Repeat) are not available in MP3 browse mode.

Selecting a track or subdirectory

To move up or down in the list to the desired track or subdirectory,

➤ press the softkeys (11) or (9) once or several times or the **↵** or **↶** button (16).

Note:

If the list contains more than 4 tracks and subdirectories, the list is automatically scrolled up or down while you are navigating in the list. If you reached the top or the bottom of the list, the arrows

of the softkeys (11) or (9) are shown only as an outline.

To play the selected track or open the selected subdirectory,

➤ press the softkey (10) or the **OK** button (18).

The playback of the selected track starts or the contents of the selected subdirectory is displayed.

Changing to the higher level directory

To change from the current to the higher level directory,

➤ press the **<** button (14).

Note:

If no additional higher level directory is displayed after pressing the **<** button (14), you have reached the top level of the CD.

Selecting playlists and tracks in MP3 playlist mode

If the MP3 CD contains playlists, you can select and play these playlists in playlist mode. For this purpose, a four-line display is shown in playlist mode. This display shows all the playlists as a list. You can select a playlist in this list and open it and then select and play a track of the playlist.

Notes:

- This device allows playing playlists in the formats M3U, PLS, WPL, ASX and RMP.
- The playlists must be stored at the top level (Root directory) of the CD.

Selecting and exiting MP3 playlist mode

To change from MP3 display to MP3 playlist mode,

➤ press the **NEXT** button (2) twice.

The "BROWSE" menu is displayed with a list of available playlists.

To exit MP3 playlist mode again,

➤ press the **NEXT** button (2).

The MP3 display is shown.

Notes:

- The functions of the MP3 display (e.g Mix and Repeat) are not available in MP3 browse mode.
- The MP3 playlist mode is only available if the MP3 CD contains playlists.

Selecting a track from a playlist

To move up or down in the list to the desired playlist,

➤ press the softkeys (11) or (9) once or several times or the **↓** or **↑** button (16).

Note:

If the list contains more than 4 playlists, the list is automatically scrolled up or down while you are navigating in the list. If you reached the top or the bottom of the list, the arrows of the softkeys (11) or (9) are shown only as an outline.

To open the selected playlist,

➤ press the softkey (10) or the **OK** button (18).

Note

To exit the open playlist again, press the **<** button (14).

The tracks of the selected playlist are shown as a list. To select a track,

- press the softkeys (11) or (9) once or several times or the **V** or **^** button (16).

To play the selected track,

- press the softkey (10) or the **OK** button (18).

Note

The device treats playlists like directories. To play the entire playlist, select the first track of the playlist and play it. All additional tracks of the playlist are then automatically played.

Fast searching (audible)

To fast search backwards or forwards,

- press and hold down the **<** or **>** button (14) until fast searching backwards/forwards begins.

Random track play (MIX)

To play the tracks in the current directory in random order,

- press the softkey "MIX" (6) once or several times until "MIX DIR" is displayed.

Info line 2 (H) permanently displays "Mix Dir".

To play the tracks contained in all the directories on the MP3 data carrier in random order,

- press the softkey "MIX" (6) once or several times until "MIX ALL" is displayed.

Info line 2 (H) permanently displays "Mix All".

Cancelling MIX

To cancel MIX,

- press the softkey "MIX" (6) once or several times until "MIX OFF" is displayed.

Info line 2 (H) no longer displays "Mix Dir" or "Mix All".

Scanning tracks (Scan)

You can scan (briefly play) all the tracks on the MP3 data carrier.

- Press the **OK** button (18) for longer than 2 seconds.

The next track will then be scanned. "SCAN" and the current track name are intermittently shown on the display.

Note:

You can set the scan time. For further information, please read the section entitled "Setting the scanning time" in the "Radio mode" chapter.

Cancelling Scan and continuing listening to a track

- Briefly press the **OK** button (18).

The currently scanned track will then continue to be played normally.

Repeating individual tracks or whole directories (RPT)

To play the current track repeatedly,

- press the softkey "RPT" (7) once or several times until "REPEAT TRACK" is displayed.

Info line 2 (H) permanently displays "Rpt Trk".

To repeat the whole directory,

➤ press the softkey "RPT" (7) once or several times until "REPEAT DIR" is displayed.

Info line 2 (H) permanently displays "Rpt Dir".

Cancelling repeat

To stop the current track or current directory from being repeated,

➤ press the softkey "RPT" (7) once or several times until "REPEAT OFF" is displayed.

Info line 2 (H) no longer displays "Rpt Trk" or "Rpt Dir".

CD changer mode

Note:

Information about handling CDs, inserting CDs and operating the CD changer can be found in the operating instructions supplied with your CD changer.

Switching to CD changer mode

➤ Press the **SOURCE** button (4) repeatedly until "CDC" appears on the display.

The CD overview is displayed. The device starts playing the first CD that the CD changer detects.

Configuring the display

In CD changer mode, you can use the **NEXT** button (2) to change between CD overview and CD changer display.

CD overview

The CD overview is displayed as soon as you start the CD changer mode. In the CD overview, all available CDs in the CD changer are displayed. You can directly select a CD with the softkeys (6), (7), (8), (10) and (11). Each of these softkeys shows

- either the CD number (e.g. "Disc 01" if the CD is located in position 1 in the CD magazine)
- or the name of the CD (how to enter a name for a CD is described in the section "Naming a CD" in this chapter)
- or a blank space if the corresponding position in the CD magazine does not contain any CD.

If CDs are located at positions 6 through 10 of the CD magazine, they are displayed on the second page of the CD overview. To change between the first and second page of the CD overview,

- press the softkey "Next" or "Previous" **9**.

CD changer display

The CD changer display shows information about the current CD and the current track. In addition, you can access additional functions, such as Repeat and Mix, in the CD changer display. For further details, please read the chapter "The display in CD, CD changer and MP3 mode".

Selecting CDs

To move up or down to another CD,

- press the **↓** or **↑** button **16** once or several times.

Note:

The device will ignore empty CD slots in the changer and slots containing invalid CDs.

To directly change to a specific CD,

- if necessary, use the **NEXT** button **2** to change to the CD overview.
- Press the softkey of the desired CD.

Selecting tracks

To move up or down to another track on the current CD,

- press the **<** or **>** button **14** once or several times.

Fast searching (audible)

To fast search backwards or forwards,

- press and hold down the **<** or **>** button **14** until fast searching backwards/forwards begins.

Repeating individual tracks or whole CDs (RPT)

- If necessary, use the **NEXT** button **2** to change to the CD changer display.

To repeat the current track,

- press the softkey "RPT" **7** once or several times until "REPEAT TRACK" is displayed.

Info line 2 **H** permanently displays "Rpt Trk".

To repeat the current CD,

- press the softkey "RPT" **7** once or several times until "REPEAT CD" is displayed.

Info line 2 **H** permanently displays "Rpt CD".

Cancelling repeat

To stop the current track or current CD from being repeated,

- press the softkey "RPT" **7** once or several times until "REPEAT OFF" is displayed.

Info line 2 **H** no longer displays "Rpt Trk" or "Rpt CD".

Random track play (MIX)

- If necessary, use the **NEXT** button (2) to change to the CD changer display.

To play the tracks on the current CD in random order,

- press the softkey "MIX" (6) once or several times until "MIX CD" is displayed.

Info line 2 (H) permanently displays "Mix CD".

To play the tracks on all inserted CDs in random order,

- press the softkey "MIX" (6) once or several times until "MIX ALL" is displayed.

Info line 2 (H) permanently displays "Mix All".

Cancelling MIX

- press the softkey "MIX" (6) once or several times until "MIX OFF" is displayed.

Info line 2 (H) no longer displays "Mix CD" or "Mix All".

Scanning all tracks on all CDs (Scan)

To scan (briefly play) all the tracks on all the inserted CDs in ascending order,

- press the **OK** button (18) for longer than 2 seconds.

The next track will then be scanned. "SCAN" and the current track number are intermittently shown on the display.

Note:

You can set the scan time. For further information, please read the section entitled "Setting the scanning time" in the "Radio mode" chapter.

Stopping Scan

To stop scanning,

- briefly press the **OK** button (18).

The currently played track will then continue to be played normally.

Naming a CD (CDN)

You can name the individual CDs in the CD changer for easier identification. In addition, you can change or delete the name of a CD. The device is capable of storing names for up to 30 CDs.

Naming a CD or changing a name (Edit CD Name)

- If necessary, use the **NEXT** button (2) to change to the CD changer display.

- Press the softkey "CDN" (11).

The menu for editing CD names is displayed.

To rename the current CD or change the name of the CD,

- press the softkey "Edit CD Name" (6).

The 7-character text input is displayed. The first character is highlighted.

To switch between the entry positions,

- press the < or > button (14).

To select a character at an entry position,

- press the **↖** or **↘** button (16).

To save the name entered and to exit the text input,

- press the **OK** button (18).

Deleting CD names (Clear CD Name / Clear All Names)

➤ If necessary, use the **NEXT** button (2) to change to the CD changer display.

➤ Press the softkey "CDN" (11).

The menu for editing CD names is displayed.

To delete the name of the current CD,

➤ press the softkey "Clear CD Name" (11) for longer than 2 seconds.

To delete the names of all CDs,

➤ press the softkey "Clear All Names" (10) for longer than 2 seconds.

Deleting the names is briefly confirmed by the display "Clearing" and the menu is exited.

Clock

Adjusting the time (Time Setting)

➤ Press the **MENU** button (17).

The menu is displayed.

➤ Press the softkey "Clock Settings" (11).

The menu is displayed.

➤ Press the softkey "Time Setting" (6).

The "Time Set" menu with the currently set time is displayed. The hours are highlighted.

To switch between hours and minutes,

➤ press the < or > button (14).

To adjust hours or minutes,

➤ press the **▲** or **▼** button (16).

When you have finished making your changes,

➤ press the **OK** button (18) repeatedly until you reach the desired menu level for additional settings or completely exit the menu.

Selecting the 12/24-hour clock mode (24 H Mode)

➤ Press the **MENU** button (17).

The menu is displayed.

➤ Press the softkey "Clock Settings" (11).

The "Clock" menu is displayed.

➤ Press the softkey "24 H Mode" (10) to activate or deactivate the 24-h mode:

- : The time is displayed in 24-h mode.
- : The time is displayed in 12-h mode.

When you have finished making your changes,

- press the **OK** button (18) repeatedly until you reach the desired menu level for additional settings or completely exit the menu.

Displaying time permanently with device switched off and ignition switched on (Off Clock)

- Press the **MENU** button (17).

The menu is displayed.

- Press the softkey "Clock Settings" (11).

The "Clock" menu is displayed.

To display the time when the device is off and the vehicle ignition is on,

- press the softkey "Off Clock" (10):
 - : The time is displayed.
 - : The time is not displayed.

When you have finished making your changes,

- press the **OK** button (18) repeatedly until you reach the desired menu level for additional settings or completely exit the menu.

Note:

You can replace the factory-selected wallpaper of the time display with your own. For further details, please read the section "Changing wallpapers of the display" in the chapter "Adjusting the display".

Sound

You can adjust the sound settings (bass, middle and treble) separately for each source (radio, CD, CD changer, AUX, traffic announcement and telephone/navigation). The volume distribution settings (balance and fader) and X-BASS apply to all the audio sources except for traffic announcements and telephone/navigation. You can adjust the volume distribution settings separately for traffic announcements and telephone/navigation.

Note:

The settings of the sound for traffic announcements and telephone/navigation can only be made during a traffic announcement or during a telephone call/voice output.

This device features a digital 3-band equalizer. This equalizer allows for selecting one frequency each for bass, treble and middle and to adjust the level for the selected frequency between -7 and +7. In addition, you can adjust the quality factor for bass and middle.

The quality factor Q determines the filter quality of the equalizer, i.e. the edge steepness and filter bandwidth, dependent upon the characteristic frequency. A low quality factor means a low edge steepness and a high filter bandwidth; a high quality factor means a high edge steepness and a low filter bandwidth.

The following table shows an overview of the setting options:

	Bass	Treble	Middle
Level (G)	x	x	x
Frequency (Freq)	x	x	x
Quality factor (Q)	x	-	x

To adjust the bass and treble levels quickly and conveniently for a simple sound adjustment, these "Bass" and "Treble" settings are located directly in the "Audio" menu.

Audio			
	Bass	Treble	
Level	x	x	G
Frequency	Freq	Freq	Freq
Quality factor	Q	-	Q

To adjust the bass and treble levels, read the chapters "Adjusting Bass" and "Adjusting Treble".

To fully utilise the equalizer functions, the other settings can be made in the submenu "Enhanced Audio" of the "Audio" menu. In the submenus "E-Bass", "E-Treble" and "Middle", you can perform the settings "Freq" (frequency) and "Q" (quality factor, for bass and middle only) as well as "G" (level, for middle only):

Audio			
	Bass	Treble	
Level	x	x	G
Frequency	Freq	Freq	Freq
Quality factor	Q	-	Q
	E-Bass	E-Treble	Middle
Enhanced Audio			
Audio			

For advanced settings, please read the chapters "Adjusting enhanced bass settings (Enhanced Bass)", "Adjusting enhanced treble settings (Enhanced Treble)" and "Adjusting middle settings (Middle)".

Adjusting Bass

➡ Press the **MENU** button (17).

The menu is displayed.

➡ Press the softkey "Audio Settings" (6).

The "Audio" menu is displayed.

➡ Press the softkey "Bass" (11).

The currently set bass is displayed.

➡ Press the **∨** or **∧** button (16) or the **<** or **>** button (14) to adjust the level between -7 and +7.

When you have finished making your changes,

➡ press the **OK** button (18) repeatedly until you reach the desired menu level for additional settings or completely exit the menu.

Adjusting Treble

- Press the **MENU** button (17).

The menu is displayed.

- Press the softkey "Audio Settings" (6).

The "Audio" menu is displayed.

- Press the softkey "Treble" (6).

The currently set treble is displayed.

- Press the **∇** or **▲** button (16) or the **<** or **>** button (14) to adjust the level between -7 and +7.

When you have finished making your changes,

- press the **OK** button (18) repeatedly until you reach the desired menu level for additional settings or completely exit the menu.

Setting the left/right volume distribution (balance)

- Press the **MENU** button (17).

The menu is displayed.

- Press the softkey "Audio Settings" (6).

The "Audio" menu is displayed.

- Press the softkey "Balance" (7).

The currently adjusted left/right volume distribution is displayed.

- Press the **∇** or **▲** button (16) or the **<** or **>** button (14) to adjust the volume distribution between -9 and +9.

When you have finished making your changes,

- press the **OK** button (18) repeatedly until you reach the desired menu level for additional settings or completely exit the menu.

Adjusting the front/rear volume distribution (fader)

- Press the **MENU** button (17).

The menu is displayed.

- Press the softkey "Audio Settings" (6).

The "Audio" menu is displayed.

- Press the softkey "Fader" (8).

The currently adjusted front/rear volume distribution is displayed.

- Press the **∇** or **▲** button (16) or the **<** or **>** button (14) to adjust the volume distribution between -9 and +9.

When you have finished making your changes,

- press the **OK** button (18) repeatedly until you reach the desired menu level for additional settings or completely exit the menu.

Adjusting enhanced bass settings (Enhanced Bass)

You can select one of four 4 bass frequencies (60 Hz, 80 Hz, 100 Hz, 200 Hz) as well as one of 4 quality factors (1.0, 1.25, 1.5, 2.0).

Note:

For further information on setting the bass level, read the section entitled "Adjusting Bass" in this chapter.

Adjusting bass frequency and quality factor

- Press the **MENU** button (17).

The menu is displayed.

- Press the softkey "Audio Settings" (6).

The "Audio" menu is displayed.

- Press the softkey "Enhanced" (9).

The "Enhanced Audio" menu is displayed.

- Press the softkey "Enhanced Bass" (6).

The current settings for bass frequency and quality factor are displayed.

- Press the < or > button (14) to change between the setting options "Freq" (bass frequency) and "Q" (quality factor).

- Set the bass frequency and quality factor each with the ∇ or \blacktriangledown button (16).

When you have finished making your changes,

- press the **OK** button (18) repeatedly until you reach the desired menu level for additional settings or completely exit the menu.

Adjusting enhanced treble settings (Enhanced Treble)

You can select 1 of 4 treble frequencies (10 kHz, 12.5 kHz, 15 kHz, 17.5 kHz).

Note:

For further information on setting the treble level, read the section entitled "Adjusting Treble" in this chapter.

Adjusting the treble frequency

- Press the **MENU** button (17).

The menu is displayed.

- Press the softkey "Audio Settings" (6).

The "Audio" menu is displayed.

- Press the softkey "Enhanced" (9).

The "Enhanced Audio" menu is displayed.

- Press the softkey "Enhanced Treble" (7).

The current setting for treble frequency is displayed.

- Press the ∇ or \blacktriangledown button (16) or the < or > button (14) to adjust the treble frequency.

When you have finished making your changes,

- press the **OK** button (18) repeatedly until you reach the desired menu level for additional settings or completely exit the menu.

Adjusting middle settings (Middle)

You can select one of 4 middle frequencies (500 Hz, 1,000 Hz, 1,500 Hz, 2,500 Hz) and set the level for the selected frequency between -7 and +7. You can also select one of 4 quality factors (0.5, 0.75, 1.0, 1.25).

Adjusting middle frequency, level and quality factor

- Press the **MENU** button (17).

The menu is displayed.

- Press the softkey "Audio Settings" (6).

The "Audio" menu is displayed.

- Press the softkey "Enhanced" (9).

The "Enhanced Audio" menu is displayed.

- Press the softkey "Middle" (11).

The current settings for middle frequency, level and quality factor are displayed.

- Press the < or > button (14) to change between the setting options "Freq" (centre frequency), "G" (level) and "Q" (quality factor).

- Set the middle frequency, level and quality factor each with the **▲** or **▼** button (16).

When you have finished making your changes,

- press the **OK** button (18) repeatedly until you reach the desired menu level for additional settings or completely exit the menu.

Preamplifier output (Preamp-Out/Sub-Out)

You can use the preamplifier outputs (Preamp-Out) of the car sound system to connect external amplifiers. In addition, you can connect an amplifier for operating a subwoofer to the integrated dynamic low-pass filter of the device (level and cut-off frequency can be adjusted).

For this purpose, the amplifiers must be connected as described in the installation instructions.

Adjusting the Sub-Out level and Sub-Out cut-off frequency (Subout)

The sub-out level can be adjusted in 8 increments (0 to +7). You can also select 1 of 3 cut-off frequencies: 80 Hz, 120 Hz, Hz and 160 Hz.

- Press the **MENU** button (17).

The menu is displayed.

- Press the softkey "Audio Settings" (6).

The "Audio" menu is displayed.

- Press the softkey "Enhanced" (9).

The "Enhanced Audio" menu is displayed.

- Press the softkey "Subout" (10).

The current settings for the Subout level and the cut-off frequency are displayed.

- Press the **<** or **>** button (14) to select the cut-off frequency.

- Press the **▲** or **▼** button (16) to select the increase for the selected cut-off frequency.

When you have finished making your changes,

- press the **OK** button (18) repeatedly until you reach the desired menu level for additional settings or completely exit the menu.

X-Bass

X-Bass allows you to increase the bass at low volume.

The selected X-Bass setting is effective for all audio sources (radio, CD, CD changer or AUX).

For X-Bass, either the basic function X-Bass boost or the enhanced X-Bass settings (Enhanced X-Bass) are available. The basic function allows you to adjust the X-Bass boost. The enhanced X-Bass settings also allow you to select an X-Bass frequency.

Adjusting X-Bass boost (X-Bass)

The X-Bass increase can be set in increments of 0 to 3.

"0" means that the X-BASS function is switched off.

- Press the **MENU** button (17).

The menu is displayed.

- Press the softkey "Audio Settings" (6).

The "Audio" menu is displayed.

- Press the softkey "X-Bass" (10).

The currently adjusted X-Bass increase is displayed.

- Press the **∨** or **∧** button (16) or the **<** or **>** button (14) to adjust the X-Bass increase.

When you have finished making your changes,

- press the **OK** button (18) repeatedly until you reach the desired menu level for additional settings or completely exit the menu.

Adjusting enhanced X-Bass settings (Enhanced X-Bass)

You can adjust an increase between 0 (X-Bass function off) and 3 for X-Bass. You can select whether the increase should affect the entire X-Bass frequency range (setting "Flat") or purposefully only one of 3 X-Bass frequencies (50 Hz, 100 Hz, 200 Hz).

- Press the **MENU** button (17).

The menu is displayed.

- Press the softkey "Audio Settings" (6).

The "Audio" menu is displayed.

- Press the softkey "Enhanced" (9).

The "Enhanced Audio" menu is displayed.

- Press the softkey "Enhanced X-Bass" (8).

The current settings for X-Bass frequency and increase are displayed.

- Press the < or > button (14) to select the setting "Flat" or a specific X-Bass frequency.

- Press the **▲** or **▼** button (16) to adjust the increase for the setting "Flat" or the selected X-Bass frequency.

When you have finished making your changes,

- press the **OK** button (18) repeatedly until you reach the desired menu level for additional settings or completely exit the menu.

Equalizer presettings (Presets)

This device features an equalizer in which the settings for the music genres "POP", "ROCK" and "CLASSIC" are already programmed.

- Press the **MENU** button (17).

The menu is displayed.

- Press the softkey "Audio Settings" (6).

The "Audio" menu is displayed.

- Press the softkey "Enhanced" (9).

The "Enhanced Audio" menu is displayed.

- Press the softkey "Presets" (9).

The equalizer presettings are displayed.

- Press the softkey "POP" (7), "ROCK" (8) or "CLASSIC" (10) to select the respective presetting, or select "P-EQ Off" (9) to activate no presetting.

When you have finished making your changes,

- press the **OK** button (18) repeatedly until you reach the desired menu level for additional settings or completely exit the menu.

Adjusting the display

Adjusting the display brightness (Brightness)

If your car sound system is installed as described in the installation instructions and your vehicle features the corresponding connection, the display brightness for day and night is switched by switching on the vehicle lighting. You can adjust the display brightness separately for night and day in steps ranging from 1 - 16.

➤ Press the **MENU** button (17).

The menu is displayed.

➤ Press the softkey "Display Settings" (7).

The "Display" menu appears.

➤ Press the softkey "Brightness" (6).

The current settings of the display brightness for "Night" and "Day" are displayed.

➤ Press the < or > button (14) to select "Night" or "Day".

➤ Press the **↔** or **↵** button (16) to adjust the display brightness for night or day.

When you have finished making your changes,

➤ press the **OK** button (18) repeatedly until you reach the desired menu level for additional settings or completely exit the menu.

Adjusting the display viewing angle (Angle)

The angle at which you, the driver, looks at the display is dependent upon, among other things, the installation position of the device and your seating position and physical size. You can increase or decrease the display contrast to perfectly read the display from your viewing angle.

➤ Press the **MENU** button (17).

The menu is displayed.

➤ Press the softkey "Display Settings" (7).

The "Display" menu appears.

➤ Press the softkey "Angle" (9).

The current setting of the display contrast is displayed.

➤ Press the **↵** or **↔** button (16) or the < or > button (14) to adjust the display contrast.

When you have finished making your changes,

➤ press the **OK** button (18) repeatedly until you reach the desired menu level for additional settings or completely exit the menu.

Activating/deactivating the screen saver (Screen Saver)

The screen saver is an image that automatically appears on the display after approx. 16 seconds after the last button is activated. The image also displays the main information of the current audio source (e.g. name or frequency of the adjusted radio station in radio mode).

Pressing any button returns you from the screen saver to the display of the current audio source.

Notes:

- The screen saver is interrupted if, for example, a traffic announcement or a phone call is received.
- As long as you are in a menu, the screen saver is not displayed.
- If the device is in demo mode, the screen saver is not displayed.
- You can replace the factory-selected image of the screen saver with your own. For further details, please read the section "Changing wallpapers of the display" in this chapter.

To switch the screen saver on or off,

➤ press the **MENU** button (17).

The menu is displayed.

➤ Press the softkey "Display Settings" (7).

The "Display" menu appears.

➤ Press the softkey "Screen Saver" (6):

- : The screen saver is switched on.
- : The screen saver is switched off.

When you have finished making your changes,

➤ press the **OK** button (18) repeatedly until you reach the desired menu level for additional settings or completely exit the menu.

Changing wallpapers of the display

You can replace the following factory-selected wallpapers with your own images:

- The wallpaper which appears if "AUX" is selected as audio source.
- The wallpaper which appears if the time is displayed while the radio is switched off and the vehicle ignition is switched on (for further details, please read the section "Displaying time permanently with device switched off and ignition switched on" in the chapter "Clock").
- The image of the screen saver (for further details, please read the section "Activating/deactivating the screen saver" in this chapter.).

For your images to be displayed, they must be created using the BMP file format. For the images to be displayed without distortion, they should ideally have a size of 270 x 96 pixels.

The images must be available as a file on a CD and this CD must be in the drive of the device.

➤ Press the **MENU** button (17).

The menu is displayed.

➤ Press the softkey "Display Settings" (7).

The "Display" menu appears.

➤ Press the softkey "CD Browser" (8).

The CD browser appears and the directories and files of the CD are displayed as a list.

Note:

If the device is in the CD or MP3/WMA mode when you start the CD browser, it automatically switches to radio mode since the CD browser searches the inserted CD for image files and music files cannot be played at the same.

To move up or down in the list to the desired image file or a subdirectory,

➤ press the softkeys **(11)** or **(9)** once or several times or the **↵** or **⏪** button **(16)**.

Note:

If the list contains more than 4 files and subdirectories, the list is automatically scrolled up or down while you are navigating in the list. If you reached the top or the bottom of the list, the arrows of the softkeys **(11)** or **(9)** are shown only as an outline.

To select the marked image files or open the marked subdirectory,

➤ press the softkey **(10)** or the **OK** button **(18)**.

To change from the current to the higher level directory,

➤ press the **<** button **(14)**.

If you selected an image files, the "Picture Download" menu is displayed.

To replace the wallpaper of the time display with the selected image file,

➤ press the softkey "Clock" **(6)**.

To replace the wallpaper of the "Aux" audio source with the selected image file,

➤ press the softkey "Aux" **(7)**.

To replace the image of the screen saver with the selected image file,

➤ press the softkey "Screen Saver" **(11)**.

The download starts and the progress is displayed. After the download completes or in case of a download error, you are returned to the CD browser. In case of a successful download, the factory-set wallpaper is immediately replaced with the selected image file.

When you have finished making your changes,

➤ press the **OK** button **(18)** repeatedly until you reach the desired menu level for additional settings or completely exit the menu.

Note:

You can replace your own wallpapers again with the factory-set ones by restoring the factory settings of the device. For further details, please read the chapter "Restoring factory settings (Norm Set)".

External audio sources

Connecting external audio sources

External audio sources, such as portable CD players, MiniDisc players or MP3 players, can be connected to the device in two ways:

1. Via the rear AUX input (if no CD changer is connected to the device).

Notes:

- An adapter cable is needed to connect an external audio source via the rear AUX input. You can obtain this cable (Blaupunkt no.: 7 607 897 093) from your Blaupunkt dealer.
 - As soon as the rear AUX input is switched on, it can be selected with the **SOURCE** button (4) (to switch on the rear AUX input, please read the following section). "AUXILIARY 1" then appears on the display.
2. Via the front AUX-IN socket.



DANGER!

Increased risk of injury from connector.

In case of an accident, the protruding connector in the front AUX-IN socket may cause injuries. The use of straight plugs or adapters can lead to an increased risk of injury.

For this reason, we recommend using angled jack plugs, e.g. the Blaupunkt accessories cable (7 607 001 535).

Note:

As soon as the front AUX-IN socket is switched on in the settings and an external audio source is connected, it can be selected with the **SOURCE** button (4) (to switch on the front AUX-IN socket, please read the following section). "AUXILIARY 2" then appears on the display.

Switching on the rear AUX input and front AUX-IN socket (Auxiliary)

For external audio sources to be played back via the rear AUX input and the front AUX-IN socket, they must be switched on in the settings.

➡ Press the **MENU** button (17).

The menu is displayed.

➡ Press the softkey "Aux Settings" (10).

The "Aux" menu is displayed.

To switch the rear AUX input on or off,

- press the softkey "Auxiliary 1" (11).
- : The rear AUX input is switched on.
- : The rear AUX input is switched off.

To switch the front AUX-IN socket on or off,

- press the softkey "Auxiliary 2" (6).
- : The rear AUX input is switched on.
- : The rear AUX input is switched off.

Note:

You can replace the factory-set wallpaper, which is shown on the display for the AUX audio source, with your own. For further details, please read the section "Changing wallpapers of the display" in the chapter "Adjusting the display".

Naming external audio sources (Edit Auxiliary)

You can name the rear AUX input and the front AUX-IN socket. An external audio source, which is connected via the rear AUX input or the front AUX-IN socket, will then appear on the display under the selected name.

- Press the **MENU** button (17).

The menu is displayed.

- Press the softkey "Aux Settings" (10).

The "Aux" menu is displayed.

To name the rear AUX input,

- press the softkey "Edit Auxiliary 1" (10).

To name the front AUX-IN socket,

- press the softkey "Edit Auxiliary 2" (7).

The 16-character text input is displayed.

The first character is highlighted.

To switch between the entry positions,

- press the < or > button (14).

To select a character at an entry position,

- press the **↔** or **↵** button (16).

To save the name entered and to exit the text input,

- press the **OK** button (18).

Restoring factory settings (Norm Set)

You can restore the original factory settings of the device.

Note:

If you restore the original factory settings of the device, your personal settings, such as the display brightness, volume and sound settings, names of external audio sources and welcome text, are lost.

To restore the factory settings,

➤ press the **MENU** button (17).

The menu is displayed.

➤ Press the softkey "Various Settings" (9).

The "Various" menu is displayed.

➤ Press the softkey "Norm Set" (11).

➤ Confirm that you really want to restore the factory setting by pressing the softkey (11) again for longer than 2 seconds. Otherwise, press the **OK** button (18) to return to the "Various" menu.

If you restore the factory settings, "NORMSET ON" is briefly shown on the display. Afterwards, the device switches off and immediately on again. All settings are returned to the factory settings.

Factory settings:

Volume of traffic announcements (Traffic Volume)	30
Power-on volume (On Volume)	20
Volume muting (Mute Volume)	0
Volume of telephone/navigation announcement (Phone Volume)	25
Bass	0
Treble	0
X-Bass	0
Seek tuning sensitivity (Sensitivity)	6
Scan time (Scan Time)	10
Switch-off time (Off Timer)	15
Programme type (Program Type)	PTY OFF
PTY language (Program Lang)	ENGLISH
Time display (Off Clock)	Off
Time (Time Setting)	0:00
Time display mode (24 H Mode)	On
Confirmation beep (Beep)	On
Regional function (Regional)	Off
Display brightness (Brightness)	DAY 16, NIGHT 15
RDS	On

Technical data

Weight	approx. 1.4 kg
Voltage supply	
Operating voltage:	10.5 – 14.4 V
Current consumption	
In operation:	max. 10 A
10 seconds after switch-off:	< 3.5 mA
Amplifier	
Output power acc. to DIN 45324:	4 x 26 W sine
max. power:	4 x 45 W
Preamplifier output (Preamp Out)	
4 channels:	3 V
Input sensitivity	
Rear AUX input:	2 V / 6 k Ω
Front AUX-IN socket:	500 mV / 6 k Ω
Tel./Navi input:	10 V / 1 k Ω
Tuner	
FM waveband (FM):	87.5 – 108 MHz
AM waveband:	531 – 1,602 kHz
LW waveband:	153 – 279 kHz
FM frequency response:	35 – 16,000 Hz
CD player	
Frequency response:	20 – 20,000 Hz

Subject to technical changes

Glossary

AF – Alternative frequency

The range of FM stations is limited. For this reason, FM programmes are distributed to different frequencies. The AF RDS service sends these frequencies to the tuner. If the reception deteriorates because the vehicle leaves the reception area of a frequency, the tuner can automatically change to the best receivable frequency.

Browser, Browse mode

A special display that allows you to navigate through the folder structure of a data carrier and to select files (e.g. music tracks, playlists, wallpapers).

EON – Enhanced Other Network

In case of a traffic announcement, the device switches over from a non-traffic information station to a traffic information station of the same station chain. After the traffic announcement, the system switches back to the previously heard programme.

Quality factor Q

It determines the filter quality of the equalizer, i.e. the edge steepness and filter bandwidth, dependent upon the characteristic frequency.

ID3 tags

ID3 tags contain additional information for MP3 files (e.g. artist, title, album, genre, year).

MP3, WMA

MP3 and WMA are audio data formats that allow for high compression with little loss in quality.

Playlist

Playback list for MP3 or WMA files In playlists, you determine the order in which certain titles should be played. They are created with an MP3 manager, such as WinAmp or Windows Media Player.

PTY – Program Type

The device searches only for stations with the previously selected programme content (e.g. news, rock, pop, sports, etc.).

Radio text

Text messages transmitted by an RDS station in addition to music and voice contributions.

RDS – Radio Data System

RDS is a service of the radio stations. Besides the conventional music and voice contributions, additional information is broadcast in the form of encrypted digital signals which can be analysed by the device (e.g. station name). The RDS services are not supported by all radio stations!

REG – Regional

Some radio stations divide their programmes into regional programmes with different contents at certain times. With the RDS function Regional, the tuner only changes to alternative frequencies of the set stations that broadcast the same regional programme.

Root folder

Main folder of a data carrier. The root folder contains all other folders.

Shape CDs

A shape CD is a CD whose form deviates from the usual circular shape. It can be cornered or contoured. The non-circular form does not allow the device to correctly center and read the CD in the drive. This results in damage to the CD drive.

Broadcasting network

A broadcasting network is the offer of several stations with different programmes of a broadcasting station.

Subwoofer, Subout

Separate low-bass loudspeaker. The device has a Subout preamplifier output. You can connect either an active subwoofer or a separate power amplifier with subwoofer.

TA – Traffic Announcement

The car sound system plays traffic reports at a predefined volume, even if you currently listen to a different audio source (e.g. CD, AUX) or if the radio is muted.

Travelstore

Automatic searching and storing of the six strongest radio stations received of the region.

Tuner

Receiving unit of the radio.

X-BASS

X-Bass allows for boosting the bass at low volume levels. This renders the sound richer at a low volume.

Index

Note:

The index also contains menu entries and the different designations of the softkeys. They are listed in capital letters.

0-9

24 h MODE 88

A

ALL 81

Alternative frequency 71

ANGLE 96

Arrow keys 57

Audio sources

CD 77

CD changer 85

External 99

MP3 80

Radio 70

AUX 98

AUXILIARY 1 100

AUXILIARY 2 100

B

BALANCE 91

Balance 91

BAND 72

Band 71

BAND button 57

BASS 90

Bass 90

Bass increase. *See* X-Bass

Bass settings, enhanced 91

BEEP 70

BRIGHTNESS 96

Brightness 96

Broadcasting network 72

Button for opening the control panel 57

Button to eject the CD from the device 57

C

CD 77

Eject 79

Inserting 77

Naming (in CD changer mode) 87

Select (in CD changer mode) 86

CD BROWSER 97

CD changer 85

CDN 87

CD overview 85

CD player 99

CD text 79

CLEAR ALL NAMES 88

CLEAR CD NAME 88

CLOCK 98

Clock. *See* Time

Confirmation beep 70

Control panel 65

D

Demo mode 67

Display

Adjusting brightness 96

Adjusting viewing angle 96

Changing the wallpaper 97

Configuring the display

In CD changer mode 85

In MP3/WMA mode 81

Display. *See* Display

Display in CD, CD changer and MP3 mode: 58

Display in radio mode 58

Increasing/decreasing contrast 96

Screen saver 96

E

EDIT AUXILIARY 1 100

EDIT AUXILIARY 2 100

EDIT CD NAME 87

ENHANCED BASS 92

ENHANCED TREBLE 92

ENHANCED X-BASS 95

Equalizer

3-band equalizer 89

Default settings 95

F

- Factory settings 101
- FADER 91
- Fader 91
- Fast search
 - In CD changer mode 86
 - In CD mode 78
 - In MP3/WMA mode 84
- Forward. *See* Fast searching

I

- ID3 tags 80, 81
- INF 81

L

- LAST VOLUME 68

M

- Memory bank 71
- MENU button 57
- MIDDLE 92
- Middle settings 92
- MiniDisc player 99
- MIX
 - In CD changer mode 87
 - In CD mode 78
 - In MP3/WMA mode 84
- MP3 80
- MP3 browse mode 82
- MP3 CD 80
- MP3 player 99
- MP3 playlist mode 83
- Mute 68
 - Muting during telephone mode 69
 - Quickly reducing the volume. *See* Mute
- MUTE VOLUME 69

N

- Navigation 69
- NEXT button 57
- NORM SET 101
- Norm Set 101

O

- OFF CLOCK 89
- OFF TIMER 66
- OK button 57
- On/Off button 57
- ON VOLUME 68

P

- PHONE VOLUME 69
- Playlist 83
- Preamp-Out 93
- Preamplifier output 93
- PRESETS 95
- Presets 95
- PROGRAM LANG 75
- PROGRAM TYPE 75
- PTY 74
- PTY OFF 75

R

- Radio 70
- RDS 70
- RDS (softkey) 71
- REGIONAL 71
- Regional 71
- Reverse. *See* Fast searching
- RPT
 - In CD changer mode 86
 - In CD mode 78
 - In MP3/WMA mode 84

S

- Safety 62
- Scan
 - In CD changer mode 87
 - In CD mode 78
 - In MP3/WMA mode 84
 - In radio mode 73
- SCAN TIME 74
- Scan time 74
- SCL
 - In CD mode 79
 - In MP3/WMA mode 81
- SCREEN SAVER
 - In the DISPLAY SETTINGS menu 97
 - In the PICTURE DOWNLOAD menu 98
- Screen saver 96
- Selecting a directory
 - In MP3 browse mode 82
 - Manually 82
- SENSITIVITY 73
- Softkeys 57
- Sound 89

- Equalizer presets 95
- X-Bass 94
- SOURCE button 57
- Station
 - Adjust 72
 - Listening 73
 - Storing 73
- Station seek tuning
 - Adjusting sensitivity 72
 - Automatic 72
- Sub-Out 93
- SUBOUT 93
- Subwoofer 93
- Switch-off 66
- Switch-on 66
- T**
- TA 76
- Telephone 69
- Time
 - 12/24-hour clock mode 88
 - Adjust 88
 - Display with switched-off device 89
- Timeout function 66
- TIME SETTING 88
- Track
 - Random track play
 - In CD changer mode 87
 - In CD mode 78
 - In MP3/WMA mode 84
 - Repeat
 - In CD changer mode 86
 - In CD mode 78
 - In MP3/WMA mode 84
- Scanning
 - In CD changer mode 87
 - In CD mode 78
- Selecting
 - In CD changer mode 86
 - In CD mode 78
 - In MP3/WMA mode
 - In MP3 browse mode 82
 - Manually 82
- TRAFFIC 76
- Traffic information 76
 - Priority 76
- TRAFFIC VOLUME 77
- Travel Store 73
- TREBLE 91
- Treble 91
- Treble settings, enhanced 92
- Tuner region 70
- TURN ON TEXT
 - In the DISPLAY SETTINGS menu 67
 - In the VARIOUS SETTINGS menu 67
- TXT 79
- V**
- Viewing angle 96
- Volume 68
 - Mute 68
 - Power-on volume 68
 - Volume for telephone audio/navigation audio 69
 - Volume for traffic announcements 76
- Volume control 57
- Volume distribution. *See* Balance, Fader
- W**
- Wallpaper 97
- Warranty 64
- Waveband 71
- Wavebands FM/MW/LW 102
- Welcome text 67
- WMA. *See* MP3
- X**
- X-BASS 94
- X-Bass 94

Bitte den ausgefüllten Gerätepass sicher aufbewahren!

Please keep the filled-in radio pass in a safe place!

Prière de conserver soigneusement la carte d'autoradio remplie !

Tenete per favore il libretto di apparecchio, debitamente riempito, in un posto sicuro!

Bewaar de ingevulde apparaatpas op een veilige plaats!

Vänligen förvara ifyllt apparatpass på säker plats!

Country:	Phone:	Fax:	WWW:
Germany	(D) 0180-5000225	05121-49 4002	http://www.blaupunkt.com
Austria	(A) 01-610 39 0	01-610 39 391	
Belgium	(B) 02-525 5444	02-525 5263	
Denmark	(DK) 44 898 360	44-898 644	
Finland	(FIN) 09-435 991	09-435 99236	
France	(F) 01-4010 7007	01-4010 7320	
Great Britain	(GB) 01-89583 8880	01-89583 8394	
Greece	(GR) 210 94 27 337	210 94 12 711	
Ireland	(IRL) 01-46 66 700	01-46 66 706	
Italy	(I) 02-369 62331	02-369 62464	
Luxembourg	(L) 40 4078	40 2085	
Netherlands	(NL) 00 31 24 35 91 338	00 31 24 35 91 336	
Norway	(N) +47 64 87 89 60	+47 64 87 89 02	
Portugal	(P) 2185 00144	2185 00165	
Spain	(E) 902 52 77 70	91 410 4078	
Sweden	(S) 08-7501850	08-7501810	
Switzerland	(CH) 01-8471644	01-8471650	
Czech. Rep.	(CZ) 02-6130 0446	02-6130 0514	
Hungary	(H) 76 511 803	76 511 809	
Poland	(PL) 0800-118922	022-8771260	
Turkey	(TR) 0212-335 06 71	0212-346 00 40	
USA	(USA) 800-950-2528	708-6817188	
Brasil (Mercosur)	(BR) 0800 7045446	+55-19 3745 2773	
Malaysia (Asia Pacific)	(MAL) +604-6382 474	+604-6413 640	

02/07 - CMAS/SCS1 (dt, gb, fr, it, nl, sw)

Gerätepass

Name: **Seattle MP57**

Typ: **7 647 453 310**

Serien-Nr: **BP**

 **BLAUPUNKT**

